

Byzance

18" Quick Sand Ride



# NEW FOR 2025 – PREVIEW

## BYZANCE TRADITIONAL [P 04 – 05]

15" HiHat Extra Hammered



16" Hammered Crash Extra Thin



20" Polyphonic Ride



22" + 24" Rides Extra Hammered



## BYZANCE BRILLIANT [P 07]

21" Flex Ride – Thomas Lang signature



## BYZANCE VINTAGE [P 11]

18" Quick Sand Ride – Benny Greb signature



## ARTIST'S CHOICE CYMBAL SETS [P 21]

Thomas Lang



## CLASSICS CUSTOM DARK [P 33]

24" Ride



## PURE ALLOY [P 22 – 23]

14" Quick Sand Hat – Benny Greb signature



10" Splash Extra Hammered



18" China Extra Hammered



18" Trash Crash Extra Hammered



## DRUM GEAR

Pro Cymbal Case + Trolley [P 51]



Pro Cymbal Backpack [P 51]



Pro Stick Bags [P 52]



Drum Rugs Large + Standard + Small [P 53]



Double Sided Pads 6" + 12" [P 54]



Bassdrum Mounted Pad 4" [P 54]



Marshmallow Pads 4" [P 54]



Practice Pads 6" + 12" [P 54]



Knee Pad 4" [P 54]



Marshmallow Knee Pad 4" [P 54]



Marshmallow Pad & Stand [P 55]



Anika Nilles Artist Series Beat Bell [P 57]



Benny Greb Artist Series Tambo Step [P 57]



Light Laptop Table Stand [P 59]



## TABLE OF CONTENTS

BYZANCE FOUNDRY RESERVE	02
BYZANCE TRADITIONAL	04
BYZANCE BRILLIANT	06
BYZANCE DARK	08
BYZANCE VINTAGE	10
BYZANCE EXTRA DRY	12
BYZANCE DUAL	14
BYZANCE JAZZ	16
BYZANCE CYMBAL SETS	18
ARTIST'S CHOICE CYMBAL SETS	20
PURE ALLOY	22
PURE ALLOY CUSTOM	24
PURE ALLOY CYMBAL SETS	26
THE ARTIST CONCEPT MODELS	28
CLASSICS CUSTOM DUAL	30
CLASSICS CUSTOM DARK	32
CLASSICS CUSTOM BRILLIANT	34
CLASSICS CUSTOM EXTREME METAL	36
CLASSICS CUSTOM CYMBAL SETS	38
HCS	40
HCS CYMBAL SETS	42
HCS PRACTICE CYMBALS	44
GENERATION X	45
SYMPHONIC CYMBALS	46
MARCHING CYMBALS	48
CYMBAL BAGS & CASES	50
STICK BAGS	52
HOLDERS, DRUMMER GLOVES & DRUM RUGS	53
PRACTICE PADS & MUTES	54
DRUM GEAR & SOUND DESIGN	56
HARDWARE	58
CLEAN & PROTECT	60



# BYZANCE

xx **FOUNDRY RESERVE** xx

MADE IN TURKEY

**A** LIMITED collection of our finest hand-made Turkish cymbals, Byzance Foundry Reserve showcases the stunning, sonically rich works of art our cymbalsmiths create. Tonality and nuance are added with extra hand-hammering, resulting in deep craters that riddle the surfaces. Coupled with wide blade lathing, these cymbals produce a clear, pronounced stick-attack note over a lush bed of even undertones.

Made in Turkey from B20 bronze, hand-hammered into shape, wide blade lathing, and traditional finish.



*Each Byzance Foundry Reserve comes with a pair of Meinl Stick & Brush Standard 5A Drumsticks, a pair of 100% cotton handling gloves, a signed certificate of authenticity, and a personal letter from Mr. Reinhold Meinl.*

HIHATS



14" B14FRH 15" B15FRH 16" B16FRH

CRASHES



18" B18FRC 19" B19FRC 20" B20FRC

RIDES



20" B20FRR 22" B22FRR 24" B24FRR

RIDES LIGHT



20" B20FRLR 22" B22FRLR 24" B24FRLR

FLAT RIDE



21" B21FRFR

CHINA RIDE



22" B22FRCHR

# Byzance

## TRADITIONAL

**S**TARTING with hand-hammering and following with hand lathing in Turkey, the word 'traditional' accurately describes their hand forged shape and deeply rooted sound. The Traditional series features our broadest voice for Byzance, with a wide variety of sizes and weights that blend into any musical setting.

Made in Turkey from B20 bronze, hand-hammered into shape, narrow blade lathing, and traditional finish.



### SPLASHES



6" B6S 8" B8S 10" B10S 12" B12S

### POLYPHONIC SPLASH



10" B10POS

### CHINAS



14" B14CH 16" B16CH 18" B18CH 20" B20CH 22" B22CH

### TRASH CHINAS



18" B18TRCH 20" B20TRCH

### HIHAT THIN



14" B14TH

### HIHATS MEDIUM



10" B10MH 13" B13MH 14" B14MH 15" B15MH

### HIHAT HEAVY



14" B14HH

### POLYPHONIC HIHAT



15" B15POH

### HIHAT EXTRA HAMMERED

*Extensive shallow hammering and steep bow support a high-pitched attack, clear definition, and a warm fundamental tone. Light top cymbal and heavy bottom provide strong control with clear response.*



15" B15EHH

**NEW**

### CRASHES THIN



14" B14TC 15" B15TC 16" B16TC 17" B17TC 18" B18TC

CRASHES MEDIUM THIN



16" B16MTC

17" B17MTC

18" B18MTC

19" B19MTC

CRASHES MEDIUM



16" B16MC

18" B18MC

20" B20MC

22" B22MC

POLYPHONIC CRASHES



18" B18POC

19" B19POC

20" B20POC

HAMMERED CRASHES EXTRA THIN

NEW



16" B16ETHC

18" B18ETHC

19" B19ETHC

20" B20ETHC

22" B22ETHC

TRASH CRASHES



16" B16TTRC

18" B18TTRC

RIDES MEDIUM



20" B20MR

21" B21MR

22" B22MR

24" B24MR

RIDES HEAVY



20" B20HR

22" B22HR

23" B23HR

POLYPHONIC RIDES

NEW



20" B20POR

21" B21POR

22" B22POR

RIDES EXTRA HAMMERED

*Extensive shallow hammering and steep bow support a high-pitched attack, clear definition, and a warm fundamental tone with little build-up. Old-school warmth, and a wash that supports but never overtakes.*

NEW



22" B22EHR

24" B24EHR

# Byzance

BRILLIANT

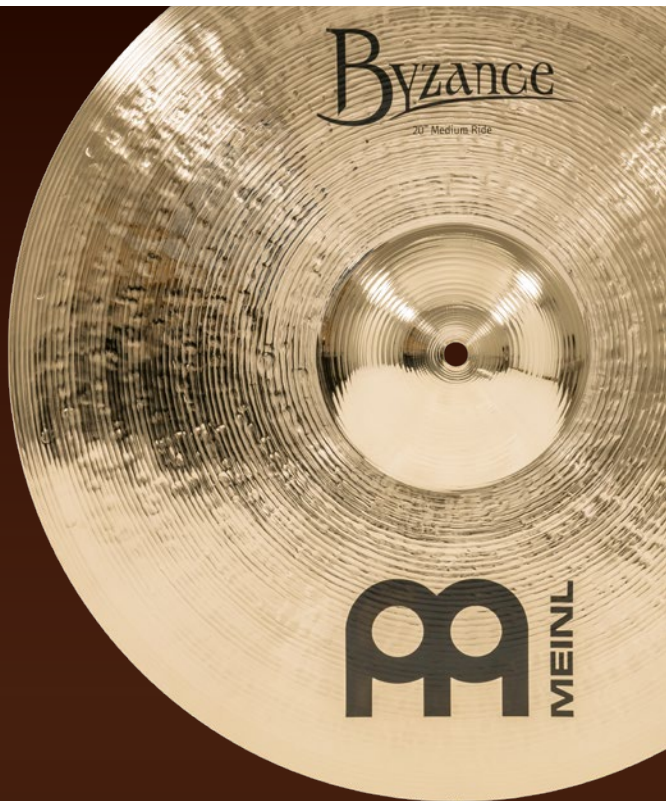

**B**UILDING on the Traditional line, Byzance Brilliant cymbals are polished to create a mirrorlike finish for a stunning look on stage. The sonic result is a slightly refined sound with a smoother, lower frequency response and added shimmer. The Heavy Hammered models feature extra weight for cut and volume.

Made in Turkey from B20 bronze, hand-hammered into shape, narrow blade lathing, and brilliant finish.

## SPLASHES



6" B6S-B 8" B8S-B 10" B10S-B

## CHINAS



14" B14CH-B 16" B16CH-B 18" B18CH-B 20" B20CH-B

## TRASH CHINA



18" B18TRCH-B

## TRASH CRASHES



16" B16TRC-B 18" B18TRC-B

## CRASHES THIN



14" B14TC-B 15" B15TC-B 16" B16TC-B 17" B17TC-B 18" B18TC-B

## CRASHES MEDIUM THIN



16" B16MTC-B 17" B17MTC-B 18" B18MTC-B 19" B19MTC-B



## CRASHES MEDIUM



16" B16MC-B 18" B18MC-B 20" B20MC-B

## RIDES MEDIUM



20" B20MR-B 21" B21MR-B 22" B22MR-B

## HIHAT MEDIUM



14" B14MH-B

## FAST HIHATS

*Thomas Lang's signature hihats*

*Holes around the edge of both the top and bottom cymbal allows the air inside the hihats to escape more quickly, creating a faster and stronger chick sound.*



13" B13FH



14" B14FH

## SERPENTS HIHATS

*Derek Roddy's signature hihats*



13" B13SH-B 14" B14SH-B

## SERPENTS RIDE

*Derek Roddy's signature ride*

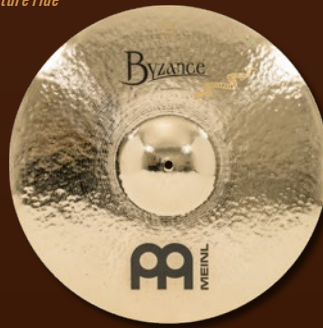

21" B21SR-B

## PURE METAL RIDE

*Chris Adler's signature ride*



24" B24PMR-B

## HEAVY HAMMERED HIHAT



14" B14HHH-B

## HEAVY HAMMERED CRASHES



18" B18HHC-B 20" B20HHC-B 22" B22HHC-B

## HEAVY HAMMERED CHINAS



18" B18HHCH-B 20" B20HHCH-B

## HEAVY HAMMERED RIDE

*The extra weight and hammering increases projection and volume while maintaining musical tonality.*



22" B22HHR-B

## FLEX RIDE

*Thomas Lang's signature ride*

*Balancing perfectly between wash and ping, it never veers into excessive wash territory. Heavy weight, hand hammered in Turkey.*



21" B21FLXR

**NEW**

# Byzance

## DARK

**H**AND-HAMMERED and completely unlathed, Byzance Dark cymbals immediately hit the sweet spot with crashes that open up just enough, then get out of the way. The hihats and rides provide clarity, cut and volume, along with a prominent dark tone brought out by their unique surfaces.

Made in Turkey from B20 bronze and hand-hammered into shape. The surfaces here are left unlathed creating the dark finish except for the Spectrum Hihats and Ride which are partially lathed in a spiral pattern.

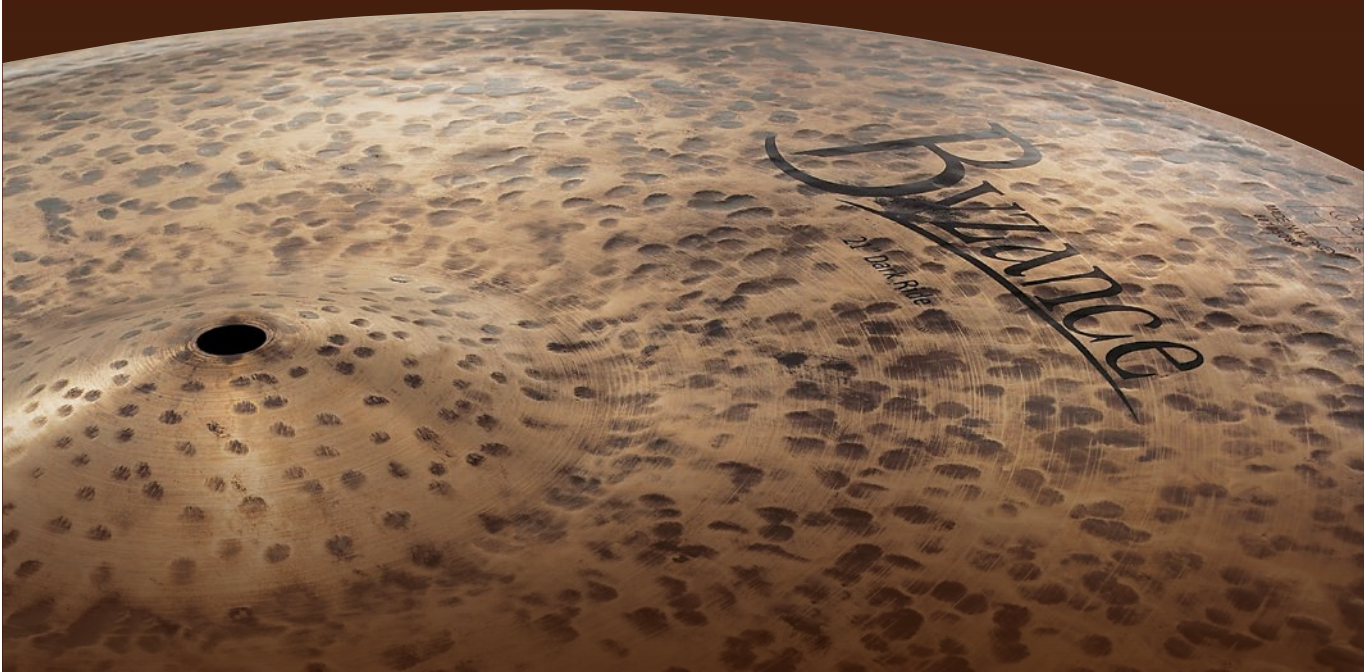

### SPLASHES



8" B8DAS 10" B10DAS

### HIHATS



13" B13DAH 14" B14DAH 15" B15DAH

### SPECTRUM HIHATS

*Rodney Holmes' signature hihats*



13" B13SH 14" B14SH

### BIG APPLE DARK HIHAT

*Small bell and thin top produce a warm, smooth tonality with dark articulation. Pair them with your favorite Big Apple ride for a highly textured expression of sound.*



15" B15BADAH

**CRASHES**



16" B16DAC 17" B17DAC 18" B18DAC 20" B20DAC

**TRASH CRASHES**



18" B18DATRC 20" B20DATRC

**TRASH CHINA**



18" B18DATRCH

**RIDES**



20" B20DAR 21" B21DAR 22" B22DAR

**BIG APPLE DARK RIDES**

*Dry articulation and crashability together with a bell that is perfectly suited for small rooms and clubs.*



20" B20BADAR 22" B22BADAR 24" B24BADAR

**BIG APPLE DARK TRADITION RIDE**



22" B22BADTR

**BIG APPLE DARK TRADITION RIDE LIGHT**



22" B22BADTLR

**BIG APPLE DARK FLAT RIDE**

*The subtle bow adds a roar and touch of sizzle to the wash for a low, breathy response.*



22" B22BADFR

**RAW BELL RIDES**

*Outstanding ride cymbal with excellent sound features and an extraordinary dark look. Untreated raw bell creates a fat, projecting sound that has a wide spectrum.*



20" B20RBR 22" B22RBR

**SPECTRUM RIDE**

*Rodney Holmes' signature ride*

*Extremely versatile ride due to the partial lathing, which allows the cymbal to balance a dry attack and light wash in a medium weight.*



22" B22SR

**DOUBLE DOWN CRASH-RIDE**

*Matt Halpern's signature ride*

*A versatile and dynamic, hand-hammered cymbal which fully functions as both a ride and crash when needed. The combination of the dark, unlathed top and lathed bottom creates a unique blend of sustain and control.*



21" B21DDCR

# Byzance

## VINTAGE

**C**RRAFTED with age in mind, the Vintage voice within Byzance has unique features that simulate the aging process of a cymbal to couple relic sounds with modern appeal. The Vintage line was born from the Sand Ride, a flagship cymbal developed with Meinl Cymbals artist, Benny Greb; now, it includes a wide array of cymbals which have helped to define the Meinl sound.

Made in Turkey from B20 bronze and hand-hammered into shape. Sand models feature narrow blade lathing and a sandblasted finish, whereas Vintage Pure models are unlathed and raw.



### EQUILIBRIUM HIHAT

*Matt Garstka's signature hihat*

Various areas sandblasted and lathed to achieve an overall balance of dryness and sustain, as well as warmth and cut. Six holes around the bottom bell increase foot chick projection.



14" B14EQH

### EQUILIBRIUM CHINA

*Matt Garstka's signature china*



20" B20EQCH

### EQUILIBRIUM RIDE

*Matt Garstka's signature ride*

A thicker cymbal overall. Thinned out edge to give it the desired crash-ability while maintaining a nice stick attack with pleasing overtones for jazz-like patterns that are common in progressive music.



22" B22EQR

### C SQUARED RIDE

*Chris Coleman's signature ride*



21" B21C2R

### SMACK STACK



10"|12"|14" B024VSM

### SMACK STACK ADD-ON PACK



8"|16" B86VSMA

### SPLASH



10" B10VS

### TRASH SPLASH



10" B10TRS

### CRASHES



16" B16VC

18" B18VC

20" B20VC

22" B22VC

### TRASH CRASHES



16" B16TRC

18" B18TRC

20" B20TRC

PURE HIHATS



14" B14VPH 15" B15VPH

PURE CRASHES



18" B18VPC 20" B20VPC

PURE TRASH CRASH



18" B18VPTRC

PURE RIDES



20" B20VPR 22" B22VPR

PURE RIDES LIGHT



20" B20VPLR 22" B22VPLR

SAND HATS

*Benny Greb's signature hats*



14" B14SAH 16" B16SAH

SAND CRASHES THIN

*Benny Greb's signature crashes*



18" B18SATC 20" B20SATC

SAND CRASH MEDIUM

*Benny Greb's signature crash*



18" B18SAMC

SAND CRASH-RIDE

*Benny Greb's signature crash-ride*



22" B22SACR

SAND RIDES

*Benny Greb's signature rides*



20" B20SAR 22" B22SAR

QUICK SAND RIDE

*Benny Greb's signature ride*

*A pre-aged heavy ride inspired by legendary modified cymbal sounds of the '70s and '80s. The sound notch, sandblasting, and weight unlock clarity and control.*



18" B18QSR

**NEW**

# Byzance

EXTRA DRY



Byzance  
EXTRA DRY

**A**LTHOUGH they appear to be raw, Byzance Extra Dry cymbals are extremely refined. Designed to be dry, fast, trashy, and low, this is one of the most intriguing voices within Byzance that attracts many drummers. The crashes, splashes, and china cymbals all explode and unleash a gritty texture from within, while the hihats and rides are crisp in definition.

Made in Turkey from B20 bronze, hand-hammered into shape, and raw finish. The bottom side of hihats, crashes, splashes and chinas are lathed, but the rides are left unlathed except for the Transition Ride, which is lathed and polished on the bottom to a brilliant finish.

**SPLASHES**



10" B10EDS 12" B12EDS

**HIHATS MEDIUM THIN**



15" B15EDMTH 16" B16EDMTH

**HIHATS MEDIUM**



13" B13EDMH 14" B14EDMH

**CHINAS**

*The underside of each china is fully lathed, while the top side remains unlathed, resulting in a sharper attack and warm lows.*

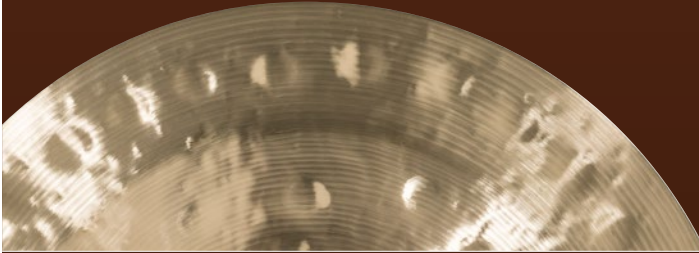

16" B16EDCH 18" B18EDCH 20" B20EDCH

**TRASH CRASH**



18" B18EDTRC

**CRASHES THIN**



16" B16EDTC 17" B17EDTC 18" B18EDTC 19" B19EDTC 20" B20EDTC

**RIDES THIN**



20" B20EDTR 22" B22EDTR

**RIDES MEDIUM**



20" B20EDMR 22" B22EDMR

**TRANSITION RIDE**

*Mike Johnston's signature ride*

*This ride has a brilliant, lathed bottom combined with an unlathed top that is slightly polished for a unique look. Opens easily for crashing, with the bell very much integrated in the overall sound.*



21" B21TSR

# Byzance

DUAL

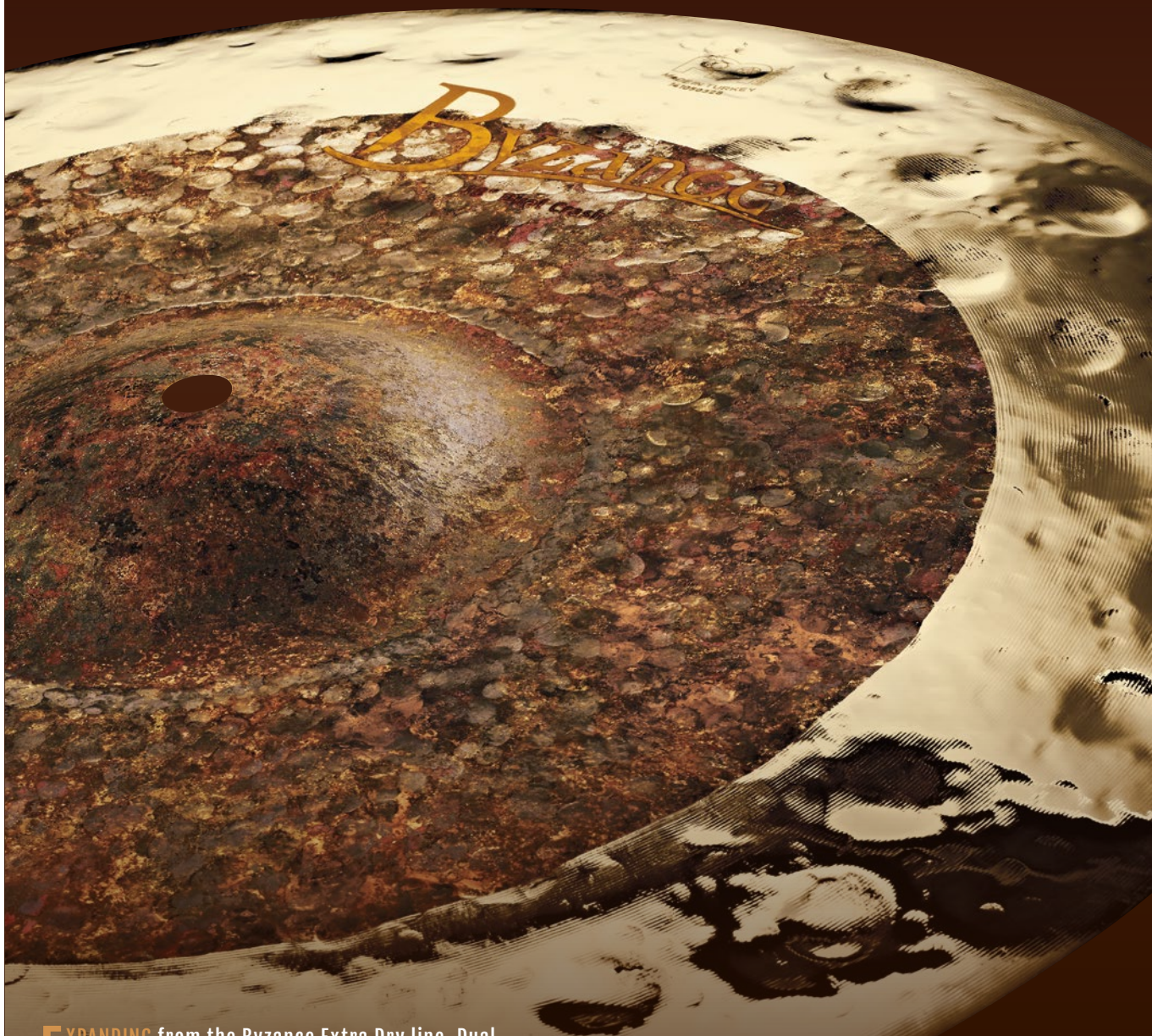

**E**XPANDING from the Byzance Extra Dry line, Dual cymbals have quickly risen in popularity and become instantly recognizable for their unique look and sound. To start, the center is raw, bearing hand-hammered markings, while the edge is lathed and buffed to a brilliant finish. The sound is similar to the look: trashy, earthy and low at first, ending with a flash of explosive brilliance.

Made in Turkey from B20 bronze, hand-hammered into shape, raw finish in center, and narrow blade lathing with brilliant finish on edges only.



*What is a Multi-Trash cymbal? This versatile cymbal makes an excellent stand-alone trash crash or extra large splash and easily stacks with another cymbal providing even more options. It can replace the top or bottom hi-hat cymbal for a trash hat effect or be combined with the top hi-hat cymbal for a crunchy tri-hat effect.*

**SPLASH**



10" B10DUS

**MULTI-TRASH**



14" B14DUMUTR

**CRASHES**



16" B16DUC

18" B18DUC

19" B19DUC

**HIHATS**



14" B14DUH

15" B15DUH

**CHINAS**

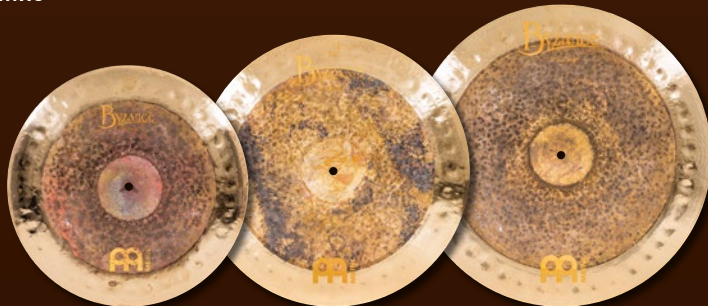

16" B16DUCH

18" B18DUCH

20" B20DUCH

**TRASH CHINAS**



18" B18DUTRCH

20" B20DUTRCH

**CRASH-RIDES**



20" B20DUCR

22" B22DUCR

**TRASH CRASHES**



16" B16DUTRC

18" B18DUTRC

20" B20DUTRC

# Byzance

## JAZZ



### SPLASH



10" B10JS

### HIHATS THIN



13" B13JTH 14" B14JTH 15" B15JTH

**B**YZANCE Jazz offers a deep well of expressive cymbals that draws players in. The hi-hats have a smooth and subtle response, and the crashes are known for a buttery feel that only develops from their hand-hammered profiles. In addition, many unique and complex ride cymbals have been created within this line to help you find your voice behind the kit.

Made in Turkey from B20 bronze, hand-hammered into shape, narrow blade lathing, and traditional finish.

### CRASHES EXTRA THIN



16" B16JETC 17" B17JETC 18" B18JETC

### CRASHES THIN



16" B16JTC 17" B17JTC 18" B18JTC 20" B20JTC

### CRASHES MEDIUM THIN



16" B16JMTC 17" B17JMTC 18" B18JMTC 20" B20JMTC

### RIDES EXTRA THIN



20" B20JETR

### RIDES THIN



20" B20JTR 22" B22JTR

### RIDES MEDIUM THIN



20" B20JMTR 22" B22JMTR

CHINA RIDE



22" B22JCHR

TRADITION HIHAT



14" B14TRH

TRADITION CRASH LIGHT



18" B18TRLC

TRADITION RIDES



20" B20TRR

22" B22TRR

TRADITION RIDE LIGHT



22" B22TRLR

BIG APPLE RIDES

*Sweet articulation and crashability together with a bell that is perfectly suited for smaller rooms and clubs.*



20" B20JBAR

22" B22JBAR

NUANCE RIDE

*Ralph Peterson's (1962 - 2021) signature ride  
Six rivets clustered near the edge create a unique, old-school sizzle effect.*



21" B21NUR

CLUB RIDES

*Wolfgang Haffner's signature rides*



20" B20JCR

22" B22JCR

SYMMETRY RIDE

*Ralph Peterson's (1962 - 2021) signature ride*



22" B22SYR

MONOPHONIC RIDE



22" B22MOR

# Byzance

## CYMBAL SETS

**S**ETS to complete or expand your kit. Put hand-made Turkish cymbals at the heart of your sound. Everything you need for performance and practice.

### BYZANCE TRADITIONAL

#### COMPLETE CYMBAL SET

14" HiHat Medium  
18" Crash Medium  
20" Ride Medium

BT-CS1



#### COMPLETE CYMBAL SET

15" Polyphonic HiHat  
18" Polyphonic Crash  
21" Polyphonic Ride

BT-CS2



#### CRASH PACK

18" Hammered Crash Extra Thin  
20" Hammered Crash Extra Thin

BMAT1



#### CRASH PACK

18" Polyphonic Crash  
20" Polyphonic Crash

BMAT3



### BYZANCE BRILLIANT

#### COMPLETE CYMBAL SET

14" HiHat Medium  
18" Crash Medium  
20" Ride Medium

BB-CS1



### BYZANCE EXTRA DRY

#### COMPLETE CYMBAL SET

14" HiHat Medium  
18" Crash Thin  
22" Ride Medium

BED-CS1



## BYZANCE DUAL

### COMPLETE CYMBAL SET

14" HiHat  
18" Crash  
20" Crash-Ride  
BDU-CS1



### COMPLETE CYMBAL SET

15" HiHat  
18" Crash  
22" Crash-Ride  
BDU-CS2



### CRASH PACK

16" Crash  
18" Crash  
BMAT4



## BYZANCE MIXED SETS

### CRASH PACK

18" Crash, Dual  
20" Hammered Crash Extra Thin  
BMIX1



### CRASH PACK

16" Crash, Dual  
18" Hammered Crash Extra Thin  
BMIX2



### CRASH PACK

18" Crash Thin, Extra Dry  
20" Hammered Crash Extra Thin  
BMIX6



## BYZANCE ASSORTED CYMBAL SET

### ASSORTED CYMBAL SET

15" HiHat, Dual  
18" Crash, Dual  
20" Hammered Crash Extra Thin  
21" Polyphonic Ride  
B15182021



# ARTIST'S CHOICE CYMBAL SETS

**F**ULL sets selected by Meinl Cymbal artists that fit their style but allow you to express yourself. Everything you need for performance and practice.

## ARTIST'S CHOICE CYMBAL SET: MATT HALPERN

- 14" Byzance Hihat Medium, Traditional
- 18" Byzance Hammered Crash Extra Thin, Traditional
- 20" Byzance Hammered Crash Extra Thin, Traditional
- 21" Byzance Double Down Crash-Ride, Dark

A-CS2



## ARTIST'S CHOICE CYMBAL SET: BENNY GREB

- 14" Byzance Sand Hat, Vintage
- 18" Byzance Sand Crash Thin, Vintage
- 20" Byzance Sand Ride, Vintage

BV-141820SA



## ARTIST'S CHOICE CYMBAL SET: BENNY GREB

- 14" Byzance Sand Hat, Vintage
- 18" Byzance Sand Crash Thin, Vintage
- 20" Byzance Sand Ride, Vintage
- 22" Byzance Sand Crash-Ride, Vintage

A-CS3



**ARTIST'S CHOICE CYMBAL SET: MATT GARSTKA**

- 14" Byzance Equilibrium Hihat, Vintage
- 18" Byzance Crash Extra Thin, Jazz
- 20" Byzance Equilibrium China, Vintage
- 22" Byzance Equilibrium Ride, Vintage

A-CS4



**MEINL  
CYMBALS**

**ARTIST'S CHOICE CYMBAL SET: CHRIS COLEMAN**

- 12" Pure Alloy Trash China
- 14" Byzance Pure Hihat, Vintage
- 19" Byzance Crash Medium Thin, Brilliant
- 21" Byzance C Squared Ride, Vintage

A-CS5



**MEINL  
CYMBALS**

**ARTIST'S CHOICE CYMBAL SET: MIKE JOHNSTON**

- 15" Byzance Foundry Reserve Hihat
- 20" Byzance Hammered Crash Extra Thin, Traditional
- 21" Byzance Transition Ride, Extra Dry

A-CS6



**MEINL  
CYMBALS**

**ARTIST'S CHOICE CYMBAL SET: THOMAS LANG**

- 14" Byzance Fast Hihat, Brilliant
- 18" Byzance Polyphonic Crash, Traditional
- 21" Byzance Flex Ride, Brilliant

A-CS7



**NEW  
MEINL  
CYMBALS**

# PURE ALLOY

MEINL  
MADE IN GERMANY



**P**URE ALLOY cymbals sonically bridge the gap between the darker and brighter cymbals in Meinl's lineup, filling the middle ground. Their shimmering, smooth sounds cut with agility and have a full range of tonality with medium sustain making them perfect for all dynamic levels. The crashes and rides have a perfect mix of effortless strength and a balanced wash, while the hihats carry a clean, refined definition.

Made in Germany from Pure Alloy bronze and hammered into shape. The traditional models feature pinpoint lathing creating the traditional finish.

## SPLASHES

*Fast response with a crisp attack and bright tonality. Great for accents or counterbalancing big crashes.*



8" PA8S 10" PA10S 12" PA12S

## SPLASH EXTRA HAMMERED

*Extra-deep hammering allows it to accent with punchy and warm tone. Clean attack, fast decay.*



**NEW**

10" PA10EHS

## CHINA



18" PA18CH

## CHINA EXTRA HAMMERED



**NEW**

18" PA18EHCH

## TRASH CHINAS

*Creating a fast attack.*



12" PA12TRCH 18" PA18TRCH

## HIHATS MEDIUM



14" PA14MH 15" PA15MH

## HIHAT EXTRA HAMMERED



15" PA15EHH

## HIHATS SOUNDWAVE



14" PA14SWH 15" PA15SWH

## QUICK SAND HAT

*Benny Greb's signature hat*

*Pre-aged hihat with definition and tonal depth – inspired by iconic recordings of the '70s and '80s. The bottom sound notch prevents airlock while boosting clarity and control.*



**NEW**



14" PA14QSH



**CRASHES THIN**

*Thin crashes open up easily with a bright punch and warm wash, then decay quickly for a short sustain.*



16" PA16TC

18" PA18TC

20" PA20TC

**CRASHES MEDIUM**



16" PA16MC

17" PA17MC

18" PA18MC

19" PA19MC

20" PA20MC

22" PA22MC

**CRASHES EXTRA HAMMERED**



16" PA16EHC

18" PA18EHC

20" PA20EHC

**CRASH-RIDES EXTRA HAMMERED**

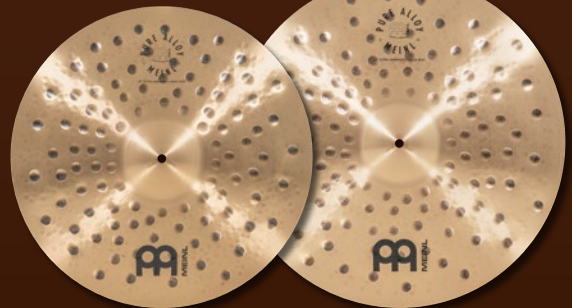

20" PA20EHC

22" PA22EHC

**TRASH CRASH EXTRA HAMMERED**

*Extra-deep hammering allows it to accent with punchy and warm tone. Hole cut-outs boost trashiness and dry the sound.*

**NEW**



18" PA18EHTRC

**RIDES THIN**



20" PA20TR

22" PA22TR

**RIDES MEDIUM**



20" PA20MR

22" PA22MR

24" PA24MR

**RIDES EXTRA HAMMERED**



20" PA20EHR

22" PA22EHR

PURE ALLOY  
  
 MEINL  
 MADE IN GERMANY  
 CUSTOM



*Smoked-bronze top paired with a brilliant bottom*

**P**URE ALLOY CUSTOM is a unique series that offers smooth tonality, a great feel under the stick, and a distinctive look on any drum kit. They produce a slightly softer attack with a warmer body and faster decay, while maintaining the bright shimmer and sustain that Pure Alloy is known for.

Made in Germany from Pure Alloy bronze and hammered into shape. To make these cymbals visually stand out, we applied a finish on top called custom smoked-bronze and polished the bottom to a brilliant finish.

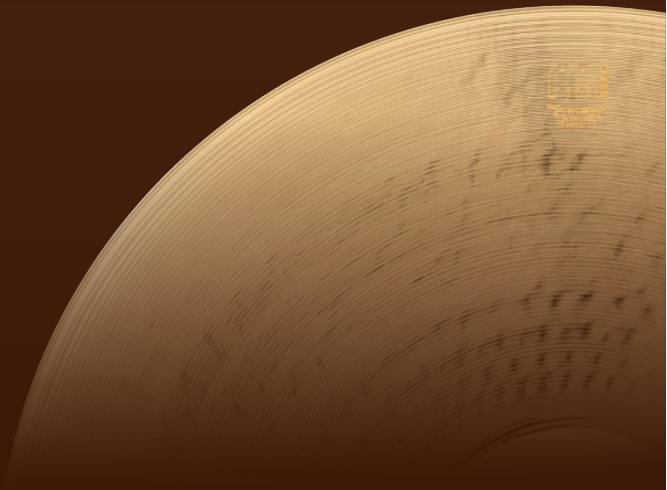

SPLASHES



8" PAC8S    10" PAC10S    12" PAC12S

TRASH SPLASH



12" PAC12TRS

TRASH STACK



12" PAC-12STK

HIHATS MEDIUM THIN



14" PAC14MTH    15" PAC15MTH

HAMMERED HIHAT EXTRA THIN

*Additional hammering works in dark tonality and warmth. Thinner weight cymbals open and react easily making them a sublime choice.*



15" PAC15ETHH

TRASH CHINAS



12" PAC12TRCH

18" PAC18TRCH

RIDES MEDIUM THIN



20" PAC20MTR

22" PAC22MTR

TRASH CRASHES

The Pure Alloy Custom Trash Crash features a medium thin weight in combination with different sized cut-outs. Brash crash sound with short sustain.



16" PAC16TRC

18" PAC18TRC

20" PAC20TRC

HAMMERED CRASHES EXTRA THIN

Producing a velvety crash under the stick due to the thinner weight, this cymbal speaks easily from whisper to roar. The additional hammering works in dark tonality and warmth.



16" PAC16ETHC

18" PAC18ETHC

20" PAC20ETHC

CRASHES MEDIUM THIN



16" PAC16MTC

17" PAC17MTC

18" PAC18MTC

19" PAC19MTC

20" PAC20MTC

CRASHES MEDIUM



16" PAC16MC

18" PAC18MC

CRASHES MEDIUM HEAVY



18" PAC18MHC

20" PAC20MHC

PURE ALLOY



MEINL  
MADE IN GERMANY

# CYMBAL SETS



**T**HE most widely used cymbal types in matched setups. Complete or expand your kit with everything you need for performance and practice.

## PURE ALLOY

### COMPLETE CYMBAL SET

14" HiHat Medium  
16" Crash Medium  
20" Ride Medium

PA141620



### COMPLETE CYMBAL SET

15" HiHat Extra Hammered  
18" Crash Extra Hammered  
22" Ride Extra Hammered

PA-CS1



### COMPLETE CYMBAL SET

14" HiHat Medium  
16" Crash Thin  
20" Ride Thin

PA-CS2



PURE ALLOY CUSTOM

COMPLETE CYMBAL SET

14" HiHat Medium Thin  
18" Crash Medium Thin  
20" Ride Medium Thin

PAC141820



EXPANDED CYMBAL SET

14" HiHat Medium Thin  
16" Crash Medium Thin  
18" Crash Medium Thin  
20" Ride Medium Thin

PAC14161820



COMPLETE CYMBAL SET

14" HiHat Medium Thin  
18" Hammered Crash Extra Thin  
20" Ride Medium Thin

PAC-CS1



EXPANDED CYMBAL SET

15" Hammered HiHat Extra Thin  
16" Hammered Crash Extra Thin  
18" Hammered Crash Extra Thin  
20" Ride Medium Thin

PAC-CS2



# THE ARTIST CONCEPT MODELS

**WORKING** closely with some of the most creative drummers on the planet, Artist Concept Models were born from collaborations with our Meinl Cymbals artists to develop new and unique sounds. Each process involved combining different cymbals to create effect stacks or auxiliary hihat which best met that artist's vision. In some cases, multiple series or alloys were used to find the perfect result. Read on to find out what the artists themselves have to say about their individual concept model.

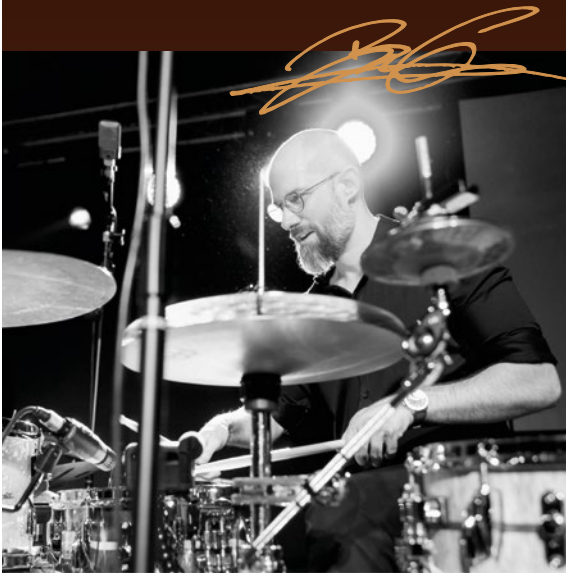

## BENNY GREB CRASHER HATS

"I wanted something that was super short, dry, clear and high frequency but still very dynamic that could fulfill a whispering shaker-like role in the music. Tough to get! So we had to create something completely unique. Four separate cymbals sandwiched together. They have different shoulders so they collapse against each other at every hit. The result is incredible. A very unique sound that blends beautifully with ghost notes and other subdivisions, but can also make a very percussive statement. They are part of my sound. I absolutely love them!"



6"/6" AC-6CRASHER    8"/8" AC-CRASHER  
[With X-Hat Auxiliary Hihat Arm]

## MATT GARSTKA TEMPORAL STACKS

"I mainly use the Temporal Stacks within complex groove and chop patterns. Their dry, trashy, staccato sound allows them to get in and out of tight spaces quickly. The stacks can absolutely be used as timekeepers, but the fun lies in orchestrating these stacks into rhythmic patterns which will for sure open up a lot of creativity."

## FAT STACK

"This stack cuts through the mix with a crunchy bite. With no ring the sustain is dry and pleasing to the ear. Its trashy quality is maintained through a wide variety of tensions, with my personal favorite being a light tension that gives its Fat Stack namesake."



8"/10" AC-TE1    10"/10" AC-TE2



18"/16" AC-FAT

## ANIKA NILLES DEEP HATS

"What I really like about my Deep Hats is that they have so many musical applications. They fill the sonic gap between my main hihats, and my crashes. I play them half open as a time keeper, very similar to crash-riding, however the Deep Hats sound softer and more articulated. That is something I prefer."



18"/18" AC-DEEP [With X-Hat Auxiliary Hihat Arm]



*Thomas Lang*

### THOMAS LANG SUPER STACK

"Its fierceness cuts through any wall of sound and allows you to slice through even the most crowded soundscape. When played softly at the edge, it produces a wide and washy sizzle, perfect for accents and punctuations at a more moderate volume. When played with the stick tip at the shoulder, its short and piercing sound is reminiscent of a trashy hihat. The Super Stack is super loud, super fast, and super short. It allows the drummer to override and supersede even the most dense frequency chaos and make a clear and concise percussive statement in every musical situation. This is the most versatile stack combination you'll find."



18"/18" AC-SUPER

### MATT HALPERN DOUBLE DOWN STACK

"To me they are the culmination of the best sounds I've been able to produce and utilize in both live and studio settings. You can configure the stack so it cuts through the loudest of music in the loudest of venues, or you can change it up and use it in the most dynamic of musical situations."

*Matt Halpern*



17"/18" AC-DOUBLEDOWN



### LUKE HOLLAND BABY STACK

"My goal with the Baby Stack was to create a combo that I could use in any setting; from metal to electronic to hip-hop. The beauty of the Baby Stack is its ability to cut through tremendously or sit back and be casually articulate. It's incredibly dynamic, and that's why I will always use it in every show, recording, or video I do."

*Luke Holland*



### BULLET STACK

"Quick as a bullet, hurts like one too. Perfect for when you need to cut and make your point. What I love about the Bullet Stack is that no matter how quickly you need it to be present and then disappear, it always delivers."



10"/12" AC-BABY



12"/16" AC-BULLET

# CLASSICS

## — CUSTOM —

### DUAL SERIES

**T**HERE is more to the Classics Custom Dual series than you may think. These cymbals are almost hypnotic, and feel at home across many styles. The lathed and polished edges have a flexible feel and create a fast response when crashed. Additionally, the dark center powers these cymbals to produce a quick punch with a complex character. The resulting sound is a harmonious blend of warmth and explosive response that will feel at home both in the studio and on stage.

The full assortment of hihats, crashes, rides, plus a splash and china is rounded out with a trash splash, trash crashes, and a trash china to offer drummers all of the necessary voicings for a wide range of diverse musical styles. With an appearance as striking as their complex sound, Classics Custom Dual cymbals will add another layer of sophistication to your setup.

Made in Germany from B12 bronze alloy, lathe formed profile, extra hammering, raw finish in center, wide blade and pinpoint lathing with brilliant finish on edges only.

#### SPLASH



10" CC10DUS

#### TRASH SPLASH



12" CC12DUTRS

#### HIHATS



14" CC14DUH

15" CC15DUH





*More about that finish: Having a dark center along with deep over-hammering gives the cymbals the ability to punch through with a dark and bold character. Lathed and highly polished edges soften the feel and create a flash of clean, high frequencies to round out the sound.*

## CRASHES



16" CC16DUC

18" CC18DUC

19" CC19DUC

20" CC20DUC

## TRASH CRASHES



16" CC16DUTRC

18" CC18DUTRC

## CHINA



18" CC18DUCH

## TRASH CHINA



16" CC16DUTRCH

## RIDES



20" CC20DUR

22" CC22DUR

# CLASSICS

## — CUSTOM —

### DARK SERIES

**A**GGRESSIVE and loud, but with a dark and warm tone, Classic Custom Dark cymbals are like nothing you have seen or heard before. Here, the cutting nature of Classics Custom is met with a shadowy and intense wash that envelops your playing with a complex, dark tone. The wide assortment of models and cymbal types are sure to help you find your sound whether you are adding on or building a complete set.

Made in Germany from B12 bronze alloy, lathe formed profile, extra hammering, wide blade lathing, and dark finish.

*Why do trash crashes have holes?  
By removing material from a cymbal, sound waves travel quickly and escape from the cymbal, creating the fast decay these cymbals are known for. The size, shape, and placement of the holes will also affect how trashy or dark the end result will sound.*

#### SPLASHES



8" CC8DAS 10" CC10DAS 12" CC12DAS

#### TRASH SPLASHES



10" CC10DATRS 12" CC12DATRS

#### HIHATS



13" CC13DAH 14" CC14DAH 15" CC15DAH

#### HIHAT HEAVY



14" CC14HDAH

#### CHINA



18" CC18DACH

#### CHINA HEAVY



18" CC18HDACH

#### TRASH CHINAS



16" CC16DATRCH 18" CC18DATRCH

CRASHES



16" CC16DAC

17" CC17DAC

18" CC18DAC

19" CC19DAC

20" CC20DAC

21" CC21DAC

CRASHES THIN



16" CC16TDAC

18" CC18TDAC

CRASHES HEAVY



16" CC16HDAC

18" CC18HDAC

TRASH CRASHES



14" CC14DATRC

16" CC16DATRC

18" CC18DATRC

TRASH STACKS



12" CC-12DASTK

16" CC-16DASTK

18" CC-18DASTK

RIDES



20" CC20DAR

22" CC22DAR

24" CC24DAR

RIDE HEAVY



20" CC20HDAR

BIG BELL RIDE HEAVY



18" CC18HBDAR

CRASH-RIDE



22" CC22DACR

# CLASSICS — CUSTOM —

BRILLIANT SERIES

CLASSICS  
— CUSTOM —  
20" Medium Ride

**B**RIGHT and focused with a shimmering response, Classics Custom is best suited for drummers who want cymbals that speak with a clear voice. The mirrorlike finish looks incredible under stage lights and adds brilliance to the sound. With so many models to choose from, the extensive lineup provides plenty of options that will allow you to find the missing cymbal you need or build the foundation for a whole new setup.

Made in Germany from B12 bronze alloy, lathe formed profile, mirror smooth surface, and brilliant finish.



*The brilliant finish on all Classics Custom cymbals adds a shimmer and brilliance both to the sound as well as the look.*

## BELL



8" CC8B-B

## SPLASHES



8" CC8S-B 10" CC10S-B 12" CC12S-B

## TRASH SPLASH



12" CC12TRS-B

## HIHAT POWERFUL



14" CC14PH-B

## HIHATS MEDIUM



14" CC14MH-B 15" CC15MH-B

## CHINAS



16" CC16CH-B 18" CC18CH-B

TRASH CHINAS



16" CC16TRCH-B 18" CC18TRCH-B

CRASHES THIN



16" CC16TC-B 18" CC18TC-B

CRASHES POWERFUL



16" CC16PC-B 18" CC18PC-B

CRASHES MEDIUM



14" CC14MC-B 15" CC15MC-B 16" CC16MC-B 17" CC17MC-B 18" CC18MC-B

TRASH CRASHES



16" CC16TRC-B 18" CC18TRC-B

TRASH STACKS



12" CC-12STK 16" CC-16STK

RIDES POWERFUL



20" CC20PR-B 22" CC22PR-B

GHOST RIDE

*Brann Dailor's signature ride*  
Unique look and sound, glassy ping,  
warm shimmer, sparkling decay.  
Raw black bell for cutting clarity.



21" CC21GR

RIDE MEDIUM



20" CC20MR-B



# CLASSICS CUSTOM

EXTREME METAL SERIES

**M**ADE for drummers who need a tough cymbal that will endure a punishing set night after night while delivering plenty of volume and cut. Exactly as their name suggests, they are an extreme version of Classics Custom. They have the same brightness, clarity, and shimmer, but with a double-shot of punch and volume for more power and precision to climb above the roar of distortion-charged amps.

Made in Germany from B12 bronze alloy, lathe formed profile, mirror smooth surface, and brilliant finish.



Ever wonder why these cymbals are called 'Extreme Metal'? It's due to the extreme nature of volume and clarity produced by their heavier weights across all models in addition to specific features, like the extra-large megabells on ride cymbals. An often overlooked feature is the additional deep hammering on each cymbal. When we developed this line, we did not want to just create louder cymbals. Instead, our goal was to create louder cymbals that were still musical. By adding the extra hammer blows, we were able to darken the tonality enough to counteract the heavier weight's increased brightness. The result is a line of full-sounding cymbals with power, volume, and clarity.

### SPLASH



10" CC10EMS-B

### CHINAS



16" CC16EMCH-B



18" CC18EMCH-B

### HIHAT



14" CC14EMH-B

### CRASHES



16" CC16EMC-B



17" CC17EMC-B



18" CC18EMC-B



19" CC19EMC-B

### BIG BELL RIDE

The smaller diameter makes it easier to fit into a multi-cymbal set, but the huge bell is still extremely cutting and powerful.



18" CC18EMBBR-B

### RIDE



20" CC20EMR-B

# CLASSICS

— CUSTOM —

## CYMBAL SETS

**C**OMplete or expand your sound with Classics Custom. All the must-have cymbal types in special tailored configurations. Everything you need for performance and practice.

### CLASSICS CUSTOM DUAL

#### COMPLETE CYMBAL SET

14" HiHat  
16" Crash  
20" Ride

CCDU141620



#### COMPLETE CYMBAL SET

15" HiHat  
18" Crash  
22" Ride

CCDU-CS1



#### EXPANDED CYMBAL SET

14" HiHat  
16" Trash Crash  
18" Crash  
20" Ride

CCDU4680



### CLASSICS CUSTOM DARK

#### COMPLETE CYMBAL SET

14" HiHat  
16" Crash  
20" Ride

CCD141620



#### EXPANDED CYMBAL SET

14" HiHat  
16" Crash  
18" China  
20" Ride

CCD-CS1





## CLASSICS CUSTOM DARK

### EXPANDED CYMBAL SET

- 10" Splash
- 14" HiHat
- 16" Crash
- 18" Crash
- 16" Trash Crash
- 18" China
- 20" Ride

CCD-CS2



### EFFECTS PACK

- 10" Splash
- 18" China

CCD-CS3



### EXPANDED CYMBAL SET

- 14" HiHat Heavy
- 16" Crash Heavy
- 18" Crash Heavy
- 20" Ride Heavy

CCD-CS4



## CLASSICS CUSTOM BRILLIANT

### COMPLETE CYMBAL SET

- 14" HiHat Medium
- 16" Crash Medium
- 20" Ride Medium

CC141620



### COMPLETE CYMBAL SET

- 14" HiHat Medium
- 18" Crash Medium
- 20" Ride Medium

CC-CS1



## CLASSICS CUSTOM EXTREME METAL

### COMPLETE CYMBAL SET

- 14" HiHat
- 18" Crash
- 20" Ride

CC-EM480



### EXPANDED CYMBAL SET

- 14" HiHat
- 16" Crash
- 18" Crash
- 18" China
- 20" Ride

CCEM-CS1



**HCS**  
MADE IN GERMANY

**HCS**  
MADE IN GERMANY

20" Crash-Ride

**MEINL**

**O**UR HCS line offers drummers of all ages and levels the highest quality cymbals at an incredible value. Meinl is proud to offer the widest variety of cymbal models and types in this price range, making this a great place to start your cymbal collection or add to it.

Made in Germany from MS63 brass alloy, lathe formed profile, wide blade lathing, and traditional finish.

BELL



8" HCS8B

SPLASHES



8" HCS8S



10" HCS10S



12" HCS12S

TRASH CRASHES



16" HCS16TRC



18" HCS18TRC

TRASH STACKS

HCS Trash Stacks provide a cutting attack and are used by drummers of all levels.

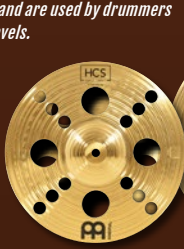

12" HCS12TRS



14" HCS14TRS



16" HCS16TRS

SMACK STACKS



10"/12"/14" HCS024SM



8"/10"/12"/14"/16" HCS80246SM

CHINAS



12" HCS12CH



14" HCS14CH



16" HCS16CH



18" HCS18CH

TRASH CHINAS



16" HCS16TRCH



18" HCS18TRCH

HIHATS



13" HCS13H



14" HCS14H



15" HCS15H

CRASHES



14" HCS14C



16" HCS16C



18" HCS18C

CRASH-RIDES



18" HCS18CR



20" HCS20CR

RIDES



20" HCS20R



22" HCS22R

BIG BELL RIDE



18" HCS18BBR



# CYMBAL SETS

**A**ll the must-have cymbal types in smart setups for any need. For learning and playing with starter to super-sized sets.

## BASIC CYMBAL SET

14" HiHat  
18" Crash-Ride  
HCS1418



## COMPLETE CYMBAL SET

14" HiHat  
16" Crash  
20" Ride  
HCS141620



## EXPANDED CYMBAL SET

14" HiHat  
16" Trash-Crash  
18" Crash  
20" Ride  
HCS14161820





**STARTER SET**

8" Splash  
13" HiHat  
HCS-CS1



**EXPANDED CYMBAL SET**

10" Splash  
14" HiHat  
16" Crash  
18" Crash  
20" Ride  
HCS-CS2



**SUPER CYMBAL SET**

10" Splash  
14" HiHat  
16" Crash  
18" Crash  
16" China  
20" Ride  
HCS-SCS



# HCS



**O**UR HCS PRACTICE CYMBALS are made for low volume playing, you can practice anytime without disturbing your family or neighbors. These practice cymbals are made from the original HCS brass alloy and have a unique hole pattern engineered by MEINL for an authentic sound and feel under the stick.

## PRACTICE HIHAT



14" P-HCS14H

## PRACTICE CRASHES

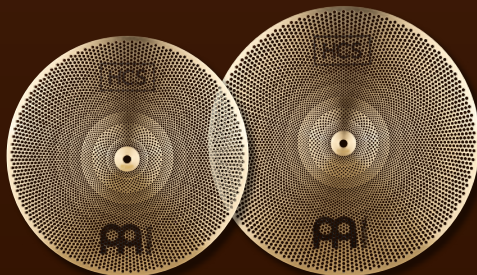

16" P-HCS16C

18" P-HCS18C

## PRACTICE RIDE



20" P-HCS20R

## PRACTICE CYMBAL SET

14" HiHat  
16" Crash  
20" Ride  
P-HCS141620



# 9 generation X



**A** SELECTION of small and unconventional cymbals, the Gen-X cymbal line is primarily used for accents and effects. These cymbals can find a home mixed with any of our other cymbal lines for a diverse setup or creation of a stack.

Made in Germany from assorted alloys, lathe formed profile, additional hammering, with various lathing and finishes.

## FX HATS

Available in 8" and 10" pairs, the FX Hats were created to provide a high, cutting, staccato attack when closed tightly and a sharp bark when played loosely. Features a custom brilliant finish with laser engraved tribal artwork.



8" GX-8FXH 10" GX-10FXH

## TRASH HAT

*Benny Greb's signature trash hat*

Created in collaboration with Benny Greb, this is a highly versatile pair of cymbals featuring a 12" sandblasted top over a 14" china. They have a distorted attack, which is perfect for simulating programmed drum sounds in a live setting. Use them as normal or auxiliary hihats, stacked multiple ways, or separate them to be played individually as a splash and china.



Trash Hat bottom

12"/14" GX-12/14TH

## DRUMBALS

*Johnny Rabb's signature drumbals*

What is a drumbal? A simple tool created from a cymbal. When applied to an acoustic snare drum, it transforms the sound into that of an electronic sample, drum machine snare, or industrial clap. It features a handle in place of the bell hole, and a soundwave edge to prevent airlock. Need to see it to believe it? Search out 'Meinl Johnny Rabb Drumbal' on our YouTube channel for a quick demo.



8" GX-8DB 10" GX-10DB



## JINGLE FILTER CHINA

*Thomas Lang's signature china*



14" GX-14FCH-J

## FILTER CHINA

*Thomas Lang's signature china*



14" GX-14FCH



# Symphonic Cymbals

HANDCRAFTED MASTERPIECES

**M**EINL Symphonic cymbals are cast from B20 bronze alloy, hand-hammered, and lathed in the same Turkish foundry as the Byzance line. We offer five weights of hand crashes and a wide range of suspended cymbals in multiple sizes enabling you to cover all cymbal applications and requirements needed in symphonic and orchestral music.

Made in Turkey from B20 bronze alloy, hand-hammered into shape, narrow blade lathing, and traditional finish, with straps included.

## TUNING FORK 440 HZ

The Tuning Fork is made in Germany and tuned precisely to the Standard Pitch of 440 Hz. The tuning fork features an ergonomically shaped grip for comfort.



TF-440

## SYMPHONIC CYMBALS THIN

Leather Handles included



16" SY-16T

18" SY-18T

20" SY-20T

22" SY-22T

## SYMPHONIC CYMBALS MEDIUM

Leather Handles included



16" SY-16M

18" SY-18M

20" SY-20M

22" SY-22M

## SYMPHONIC CYMBAL MEDIUM HEAVY

Leather Handles included



19" SY-19MH



## SYMPHONIC CYMBALS HEAVY

Leather Handles included



16" SY-16H

18" SY-18H

20" SY-20H

22" SY-22H

## SYMPHONIC CYMBALS EXTRA HEAVY

Leather Handles included



20" SY-20EH

22" SY-22EH

## SUSPENDED CYMBAL STAND

The Suspended Cymbal Stand is specifically engineered to support the cymbal as it swings freely in all directions, in order to produce its maximum sound. Designed to hold cymbals up to 24" in diameter. A cymbal stacker can be attached on top of the gooseneck for an additional cymbal.



## HAND CYMBAL STAND

Strong and solid design with three double-braced legs. The two padded cymbal cradles are easily adjustable by a standard drum key. A shelf is added between the two cymbal cradles for different drum accessories.



TMHCS

## LEATHER HANDLES

Made from the finest leather to satisfy the highest demands. Perfect grabbing a hold of quickly and recommended for orchestral applications.



BR1 [pair]

## SYMPHONIC SUSPENDED CYMBALS



14" SY-14SUS

16" SY-16SUS

17" SY-17SUS

18" SY-18SUS

20" SY-20SUS

22" SY-22SUS

# MARCHING CYMBALS



**M**ADE in Germany, Meinl's Marching Cymbals cover all aspects of indoor and outdoor drumline and marching band needs ranging from professional groups to schools. Each pair of cymbals has been tonally matched and includes a set of straps. In addition, all models in the professional range feature a brilliant finish to provide a superior visual performance. Various sizes and alloys available.

Made in Germany from assorted alloys, hammered and lathe formed profiles, various lathing and finishes, with straps included.

## PROFESSIONAL RANGE B12

Professional Leather Straps included



16" MA-B12-16M

18" MA-B12-18M

## PROFESSIONAL RANGE B10

Professional Leather Straps included



16" MA-B10-16M

## PROFESSIONAL RANGE ARENA

Professional Leather Straps included



16" MA-AR-16

18" MA-AR-18

## PROFESSIONAL RANGE ARENA DARK

Professional Leather Straps included



16" MA-AR-16DA

18" MA-AR-18DA

## PROFESSIONAL LEATHER STRAPS

Made from the finest leather for the ultimate in comfort. The strap has a soft surface and the pad provides excellent protection for the hands.



BR5 [pair]

## STUDENT RANGE BRONZE

Standard Leather Straps included



14" MA-BZ-14M

16" MA-BZ-16M

18" MA-BZ-18M

## STANDARD LEATHER STRAPS

Standard cymbal strap made from leather. It comes with a pad, which provides excellent protection for the hands.



BR3 [pair]

## STUDENT RANGE BRASS

Standard Leather Straps included



13" MA-BR-13M

14" MA-BR-14M

16" MA-BR-16M

18" MA-BR-18M

## MARCHING LEATHER STRAPS

Specially designed marching leather strap made out of the finest thin leather with extra length in order to easily hold the cymbals in the traditional marching grip.



BR2 [pair]

# CYMBAL BAGS

## WAXED CANVAS CYMBAL BAGS

These bags are designed for an understated and timeless style while being as practical as ever for any type of traveling drummer.

- MWC22BK** up to 22" Classic Black
- MWC22GR** up to 22" Forest Green
- MWC22KH** up to 22" Vintage Khaki



*Heavyweight, ultra-durable waxed canvas fabric*  
*Hihat compartment fits 15" cymbals and has one canvas divider*  
*Main compartment fits 22" cymbals and has two canvas dividers*  
*Reinforced leatherette underside and handle*  
*Adjustable backpack straps and exterior accessory pocket*



*Classic Black*



*Forest Green*



*Vintage Khaki*

## VINTAGE HYDE CYMBAL BAGS

The Meinl Vintage Hyde Cymbal Bags have all the tough useability of a touring bag with a classic good look.

- MVHC22BK** up to 22" Black
- MVHC22DB** up to 22" Dark Brown
- MVHC22LB** up to 22" Light Brown



*High-quality leatherette exterior*  
*Main compartment fits 22" cymbals and has two canvas dividers*  
*Hihat compartment fits 15" cymbals and has one canvas divider*  
*Adjustable backpack straps*  
*Exterior accessory pocket*



*Black*



*Dark Brown*



*Light Brown*

## CLASSIC WOVEN CYMBAL BAGS

The Classic Woven Bags have all the tough usability of a touring bag with timeless good looks. They are designed for functionality and style for any type of traveling drummer.

- MCCB22BK** up to 22" Black
- MCCB22GY** up to 22" Heather Gray
- MCCB22MO** up to 22" Mocha Tweed



*Heavyweight, ultra-durable 600D woven polyester with suede leather accents*  
*Main compartment fits 22" cymbals and has three dividers*  
*Hihat compartment fits 15" cymbals and has one sewn-in divider*  
*Adjustable backpack straps and reinforced padded handle*  
*Large rear pocket to stow straps and accessories*  
*EVA lined bottom to protect cymbal edges*



*Black*



*Heather Gray*



*Mocha Tweed*

# CYMBAL BAGS & CASES

## PRO CYMBAL BACKPACKS

Padded organization in a mobile-forward backpack bag. Protect your cymbals, and reduce trips loading in/out of the venue.

- MCB22-BP** up to 22" Black
- MCB22CB** up to 22" Coyote Brown

*Waist strap, sternum strap, extra padding*



*Black*

- Backpack straps, shoulder strap*
- 22" main compartment*
- 15" hi-hat compartment*
- Cymbal dividers*



*Coyote Brown*

**NEW**

## PRO CYMBAL BAGS

These bags have an external 15" compartment, cymbal dividers and a shoulder strap.

- MCB22** up to 22"
- MCB24** up to 24"



## CARBON RIPSTOP CYMBAL BAG

Ultra-durable materials make this cymbal bag ideal for travelling through packed city environments to get to the gig or studio. The all black "carbon" exterior finish is made with strong 600D woven polyester ripstop. Adjustable padded backpack straps with ABS ladder locks and chest buckle let you wear the bag comfortably on your back to keep your hands free.

- MCB22CR** up to 22"



## GIG CYMBAL BAG

Ideal for casual gigs, this bag has an easy-grip handle and holds cymbals up to 22".

- MSTCB22**



## PRO CYMBAL CASE

This 22" hard-shell case is designed for heavy-duty protection, with a through-case center bolt capable of securing approximately 9 cymbals.

- MCC22** up to 22" Black
- MCC22R** up to 22" Red

## PRO CYMBAL CASE TROLLEY

A retractable handle and heavy-duty wheels let you pull your cymbals with ease instead of lifting and carrying them.

- MCC22-TR** up to 22" Black
- MCC22R-TR** up to 22" Red



**NEW**

**NEW**

*Bolted Center Rod*

*Cymbal Cases Interior: Cushioned Contact Points*

## CYMBAL DIVIDERS

These soft dividers protect your cymbals against metal-on-metal damage in any bag or case.

- MCD-14** 2pcs 14" pack
- MCD-22** 2pcs 22" pack



# STICK BAGS

## WAXED CANVAS STICK BAGS

These bags are designed for an understated and timeless style while being as practical as ever for any type of traveling drummer.

- MWSBK** Classic Black
- MWSGR** Forest Green
- MWSKH** Vintage Khaki



## VINTAGE HYDE STICK BAGS

The Meinl Vintage Hyde Stick Bags have all the tough useability of a touring bag with a classic good look.

- MVHSBK** Black
- MVHSDB** Dark Brown
- MVHSLB** Light Brown



## CLASSIC WOVEN STICK BAGS

The Classic Woven Bags have all the tough useability of a touring bag with timeless good looks. They are designed for functionality and style for any type of traveling drummer.

- MCSBBK** Black
- MCSBGY** Heather Gray
- MCSBMO** Mocha Tweed



## PRO STICK BAGS

Easily transitions from a rugged travel companion to access-forward storage on the gig. A commonsense pocket layout sorts sticks, brushes, mallets, multi-rods, accessories, and tools.

- MSB-1** Black
- MSBCR** Carbon Ripstop
- MSBCB** Coyote Brown



## MATCHED PAIR STICK BAG

A special pocket layout lets you quickly grab matched pairs of drumsticks from the bag every time you need one.

- MPSB**



## STICK SLING BAG

The Meinl Stick Sling Bag is a wider version of our best-selling Pro Stick Bags. Inside are eleven pockets of varying size for any kind of stick, mallet, rod, brush or accessory. An oversized exterior pouch is big enough to fit bulkier items. Carry the loaded bag with its sturdy, reinforced handles or use the adjustable body strap to sling the bag across your body and keep your hands free.

- MSSB**



## COMPACT STICK BAG

This slim sized bag has two sections for four pairs of sticks or mallets making it perfect for saving space.

- MCSB**



## DELUXE STICK BAG

Featuring plenty of room, clear-window pockets and two external pouches, keep all of your sticks, brushes, and mallets in one place. Has two handles plus a strap for easy carry and elastic cord attachments to hang from a drum or stand.

- MDLXSB**



# HOLDERS, DRUMMER GLOVES & DRUM RUGS

## DRUMSTICK HOLDERS

So you don't miss a beat when you drop a stick, clamp this holder to your hihat or cymbal stand so you can quickly grab a stick.

- MC-DSH** Black
- MC-DSH-JB** Jawbreaker



## DRUMMER GLOVES

Want a better grip so you avoid stick slip and blisters? Available with or without fingers.

- MDG** M, L, XL
- MDGFL** Fingerless M, L, XL



## QUICK-SET MARKERS

Mark the position of your drums and hardware with the hook 'n' loop strips and circles.

- MQSM** 60 strips for hardware  
10 circles for drums



## DRUM RUGS

Meinl Drum Rugs are designed specifically for drummers and percussionists with tightly woven fabric that spurs and stands can dig into for a super strong grip. A non-slip rubber bottom keeps the rug from creeping as you play on any surface and is durable to prevent spurs from puncturing through.

**Drum Rugs Large:** 200 cm (6.5') x 200 cm (6.5')  
Wide enough to accommodate a drum throne as well so all hardware legs are on the same surface. Ideal for covering the entire drum riser.

- MDRL-OR** Oriental
- MDRL-BK** Black
- MDRL** Black White



**NEW**

**Drum Rugs Standard:** 160 cm (5.25') x 200 cm (6.5')  
Standard size to fit almost all common drum setups. Bag included.

- MDR-OR** Oriental
- MDR-BK** Black
- MDR-MA** Mandala – Designed by Aric Improta
- MDR** Black White

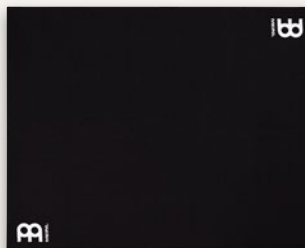

**NEW**

**Drum Rugs Small:** 140 cm (4.6') x 160 cm (5.25')  
Compact design is great for smaller setups. Bag included.

- MDRS-OR** Oriental
- MDRS-BK** Black
- MDRS** Black White



**NEW**

**E-Drum Rug:** 150 cm (4.9') x 160 cm (5.25')  
With the E-Drum Rug it's possible to manage cables, plus ensure the rest of your kit and its pedals are securely set in place and will not move. Quick-Set Markers and bag included.

- MDR-E** E-Drum Rug



# PRACTICE PADS & MUTES

## DOUBLE SIDED PADS

Two-sided practice pad with standard silicone and near-silent, muscle building "Marshmallow" foam.

- MDSP6GY** 6" Gray
- MDSP12GY** 12" Gray

Two-sided silicone and Marshmallow pad

Solid modern composite base



## BASSDRUM MOUNTED PAD

4" Marshmallow Practice Pad with padded mount attaches to your bassdrum hoop.

- MBDMP4BK** 4" Black

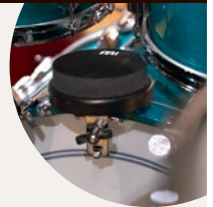

Flip over for your preferred feel and rebound

All-in-one unit for different practice needs



4" Marshmallow pad  
Padded mount for bass drum hoops  
Silent warm-ups at your kit  
Add/remove quickly

## MARSHMALLOW PADS

Practice quietly and build muscle at any hour. The Meinl Marshmallow Pads have a special formulated, super thick foam surface that provides rebound with ultra-low volume. Drop the decibels while practicing without losing a bouncy feel. The solid composite base is padded on the underside so you can play the pad on any surface. Equipped with an 8 mm threaded insert to mount on a cymbal stand.

- |                           |                           |                             |
|---------------------------|---------------------------|-----------------------------|
| <b>MMP4BK</b> 4" Black    | <b>MMP6BK</b> 6" Black    | <b>MMP12BK</b> 12" Black    |
| <b>MMP4OR</b> 4" Orange   | <b>MMP6OR</b> 6" Orange   | <b>MMP12OR</b> 12" Orange   |
| <b>MMP4SF</b> 4" Sea Foam | <b>MMP6SF</b> 6" Sea Foam | <b>MMP12SF</b> 12" Sea Foam |

13/16" (20 mm) Super Thick Marshmallow Foam

3/4" (19 mm) Solid Base

3/16" (5 mm) Non-slip Bottom

Medium rebound from special "Marshmallow" foam surface



Fits any snare stand

8 mm thread to mount on a stand



## PRACTICE PADS

Develop speed, power and precision with the Meinl rapid-rebound practice pads. Carry a 6" pocket-sized pad anywhere, or put a 12" on your snare stand to work on your chops.

- |  |  |                            |                            |
|--|--|----------------------------|----------------------------|
| <b>Thomas Lang Artist Series Practice Pads</b> | <b>Benny Greb Artist Series Masterpads</b> | <b>Meinl Practice Pads</b> | <b>Black Practice Pads</b> |
| <b>MPP-6-TL</b> 6"                             | <b>MPP-6-BG</b> 6"                         | <b>MPP-6</b> 6"            | <b>MPP-6-BK</b> 6"         |
| <b>MPP-12-TL</b> 12"                           | <b>MPP-12-BG</b> 12"                       | <b>MPP-12</b> 12"          | <b>MPP-12-BK</b> 12"       |

Thomas Lang Artist Series



Benny Greb Artist Series



Meinl



Black



## SPLIT TONE PAD

Anika Nilles Artist Series

The Split Tone Pad consists of three distinct surfaces that offer different feels and volume levels, along with a reduced rebound section on the back. It is designed to train more than a simple rudiment. With the Split Tone Pad, you can creatively mold your own systematic approach to advance your consistency, accuracy in unisons, hand independence and muscle strength. The power of this pad is in its ability to train your ears and mind for a better understanding of rhythms.

- MSTP** 12"

Three playing surfaces Bag included



## KNEE PAD MOUNT

Designed in cooperation with Benny Greb.

The Knee Pad Mount allows you to strap most any threaded (8 mm) practice pad around your knee.

- MKPM**



Adjustable strap to secure in place

## 4" KNEE PAD

With its 4" compact size and light weight, this pad sits on your knee and can be secured with the adjustable strap.

- MKPP-4** Meinl
- MKPP4BK** Black

**NEW**

Adjustable strap to secure in place



## 4" MARSHMALLOW KNEE PAD

Practice silently virtually anywhere with no setup.

- MKMP4BK** Black

**NEW**



4" Marshmallow pad  
Adjustable leg strap  
Silent practice virtually anywhere  
No setup



## PRACTICE PAD STAND

Ultra-compact and easily collapsible, the Meinl Practice Pad Stand is a lightweight, convenient option for practicing. Made from durable black powder coated steel, this stand reaches a maximum height of 37" (94 cm) with a minimum height of 19" (48 cm). Foldable legs make it easy to stow.

**MPPS**



*A threaded 8 mm connector allows you to mount most pads.*



## MARSHMALLOW PAD & STAND

4" Marshmallow practice pad and lightweight, travel-friendly stand combo.

**MMP4BK-MPPS**

**NEW**



*4" Marshmallow pad with lightweight stand*

*Near-silent foam builds muscle*

*Easily collapsible and height adjustable*



## DYNAMIC PEDAL PAD

*Designed in cooperation with Benny Greb.*

Advanced Bass Drum Pedal Practice Pad for single or double kick that responds at any dynamic level and helps you develop control, independence and feel in addition to speed.

**MDPP**



*Usable with any bass drum pedal*



## DYNAMIC PEDAL PAD ATTACHMENT

The Meinl Dynamic Pedal Pad Attachment is a pad surface replacement for the Meinl Dynamic Pedal Pad, which was designed in cooperation with Benny Greb. This pad attachment works for single and double kick practice.

**MDPPA**



## CYMBAL MUTES & DRUM MUTES

Made to fit over your cymbals or lay directly on your drumheads to dampen the vibrations as well as reduce attack and volume. You can practice for hours without disturbing close neighbors.

- MCM-14** 14" Hihat (2pcs)
- MCM-16** 16" Crash
- MCM-18** 18" Crash
- MCM-20** 20" Ride

Available Sets:

- MCM-141620** 14", 16", 20"
- MCM-14161820** 14", 16", 18", 20"



*Mute your cymbals for quiet practicing*

- MDM-10** 10"
- MDM-12** 12"
- MDM-13** 13"
- MDM-14** 14"
- MDM-16** 16"
- MDM-18** 18"

Available Sets:

- MDM-10121414** 10", 12", 14", 14"
- MDM-10121416** 10", 12", 14", 16"
- MDM-12131416** 12", 13", 14", 16"



# DRUM GEAR & SOUND DESIGN

## DRUM HONEY & DRUM HONEY FISHBOWL

Meinl Drum Honey instantly transforms your drum sound into a warm and sweet tone with practically no effort. They can be removed from any surface as needed. Vital for session drummers and studio engineers as well as being used in houses of worship and venues where sound control is needed. Drum Honey is washable by using a drop of dish soap and water. Let them air dry (no direct sunlight), and their stickiness will recover. The Meinl Drum Honey is non-toxic.

The Meinl Drum Honey Fishbowl is filled with 16 packs of Drum Honey for easy, impulse purchase.

- MDH** Drum Honey
- VE16-MDH** Drum Honey Fishbowl



*They also work great on cymbals*

## DRUM HONEY ASSORTMENT

The assortment includes 12 dampening gel pads:  
 6 x small 1,52 cm (0.6")  
 4 x medium 2,54 cm (1")  
 2 x large 3,55 cm (1.4")

- MDHA** Drum Honey Assortment



## DRUM HONEY SLAB

The Meinl Drum Honey Slab instantly transforms your drum sounds into a meaty, warm, and sweet tone with practically no effort. This extra-thick and large dampening gel pad has a rectangular shape measuring 3.54" (9 cm) long x 2.36" (6 cm) wide x 0.31" (0,8 cm) thick. It can be placed on any drumhead type and removed easily as needed.

- MDHS** Drum Honey Slab



*Comes with storage box*

## MAGNETIC SUSTAIN CONTROL

*Designed in cooperation with Benny Greb.*

Easily control the sustain and dampen the tone of your cymbals, cowbell, or other instrument with the Meinl Magnetic Sustain Control. Simply adjust the effect by positioning the magnets on your instrument.

- MCT**
- 2pcs 16 x 4 mm - light damping
- 2pcs 16 x 9 mm - heavy damping
- With storage barrel



*Simply place the magnets on the cymbal*

## SIZZLE RIVETS

Add some character to the sustain of your cymbal with these sizzling brass plated rivets. Simply insert the rivet into the hole, and bend the bottom end out.

- CY-RIVET-BR** Set of three brass plated steel rivets



*These are designed to work for cymbals with existing holes. Drilling new holes in your cymbal will void the warranty.*

## CYMBAL BACON

The Meinl Cymbal Bacon adds a sizzle sound to any ride, crash, or effect cymbal in your set up by simply placing the chain on top of your cymbal. Easy to use on any cymbal stand and does not scratch or harm cymbal finishes. Available as a standard and heavy version.

- BACON** Standard version
- HBAC** Heavy version

*Standard version*

*Heavy version*



## BYZANCE DRUM KEYS

The Byzance Drum Keys are eye-catching and functional. One side shows off the Byzance logo, while the other features the Meinl logo. Easy to tune with, the wing design is wide enough to make quick adjustments or head changes. A key ring hole allows you to attach the Byzance Drum key to your everyday set of keys. Available in antique bronze- and antique tin plated finish.

- MBKB** Antique bronze plated finish
- MBKT** Antique tin plated finish



*Antique bronze plated finish*



*Antique tin plated finish*



*Back*



## MIKE JOHNSTON ARTIST SERIES GROOVE BELL

The Meinl Mike Johnston Artist Series Groove Bell was developed to offer drummers a cowbell that sits perfectly in the mix of a band while providing the percussive spark required in their grooves. Included are two magnets (one small & one large, based on Benny Greb's Magnetic Sustain Control idea) that dampen the sustain and muffle unwanted ring. The Groove Bell is highlighted with a vintage steel finish.

**MJ-GB**



## ANIKA NILLES ARTIST SERIES BEAT BELL

Comes with the Meinl Rim Clamp to attach to your snare. No stand required. This 5" steel cowbell can easily go with any style.

**AN-BB**



**NEW**



*Designed with Anika Nilles*

*Attaches directly to your snare*

*No stand required*

*Includes Rim Clamp, U-shaped rod, Drum Honey, Drum Key*

*Material: Special steel alloy*

## AJUCH BELLS

Meinl Ajuch Bells are handcrafted from cast brass bells and are available in three sizes for various pitch and tone. Each rope is hand tied and features a solid brass hook to secure the bells onto any hihat, cymbal, drum, or stand. Canvas bag included.

**MABS** Small  
**MABM** Medium  
**MABL** Large



## BACKBEAT PRO TAMBOURINE

Featuring a brass ring made from Meinl Cymbal alloy with brass jingles attached, any drummer can add a tambourine effect to a snare backbeat or floor tom rhythm.

**BBP14** 14" in diameter



## BENNY GREB ARTIST SERIES TAMBO STEP

A hands-free tambourine you play with your foot. The small beater is designed for a short sustain with strong jingle response for precise rhythms. Works with any bass drum pedal (pedal not included).

**BG-TS**



**NEW**

*Designed with Benny Greb*

*Hands-free tambourine*

*Great for multi-instrumentalists, guitarists, and cajon players*

*Sand blasted solid brass jingles*

*Comes with mount, Z-shaped rod, and beater*

## BENNY GREB ARTIST SERIES HIHAT TAMBOURINE

True to his signature cymbals, the Benny Greb Artist Series Hihat Tambourine features sand blasted jingles that have a dry, vintage sound and unique matte appearance. The eight pairs of brass jingles produce a mellow, yet edged 'ching' effect that will lift any groove.

**HTHHBG**



## CHING RINGS

Incorporate a 'ching' into your grooves by placing one of the three different Meinl Ching Rings directly on your cymbals!

**CRING** 5 pairs of stainless steel jingles, steel ring  
**DCRING** 5 pairs of stainless zinc jingles, steel ring  
**SCRING** 6 pairs of stainless steel jingles, foam ring



## SUPER FLEX HIHAT TAMBOURINE

The highly responsive tambourine is made with a flexible and lightweight Mylar frame that contours to the profile of your cymbal. This focuses all energy on the jingles, fully activating them to give you outstanding hihat foot tambourine response without a heavy, lagging feel. Equipped with ten pairs of stainless steel jingles that deliver a bright sound with plenty of volume to shine through the mix. Great for live or studio use.

**SFHHT**



# HARDWARE

## CYMBAL HOLDERS

Instead of getting another cymbal stand, use one of these arms with a Meinl Multi Clamp (not included) to add a cymbal or percussion piece to your kit.

- MC-CY** S-shaped
- MC-CY1** S-shaped, long
- MC-CY2** Z-shaped

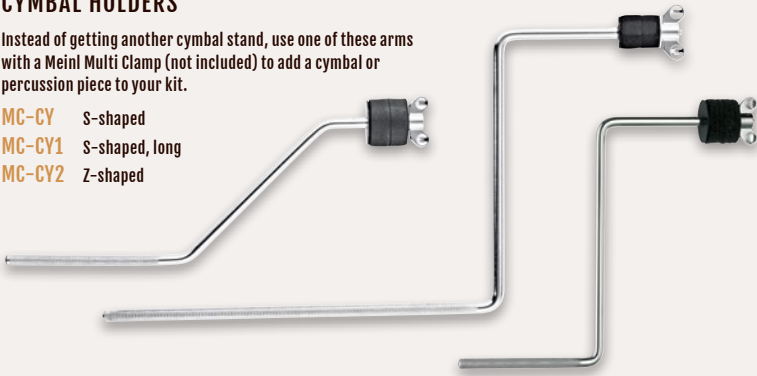

## CYMBAL STACKERS

Double up the cymbals on any one of your stands with a short or long stacker.

- MC-CYS** 6 mm thread, long version
- MC-CYS8** 8 mm thread, long version
- MC-CYS8-S** 8 mm thread, short version



## MULTI-CLAMP FOR STANDS

Attach a cymbal or tom arm to any stand with the Meinl Multi-Clamp. This two-sided clamp is adjustable to fit tubes or stands measuring 13 mm to 34 mm in diameter, accommodating most hardware pieces. Made from solid aluminum and durable synthetic thumb screws.

**PMC-1**



## MULTI CLAMP, ONE MOUNT

With this length-adjustable clamp and rod you can position a timbale, cowbell, block or mountable tambourine anywhere within your set-up.

**MC-1** Includes straight rod

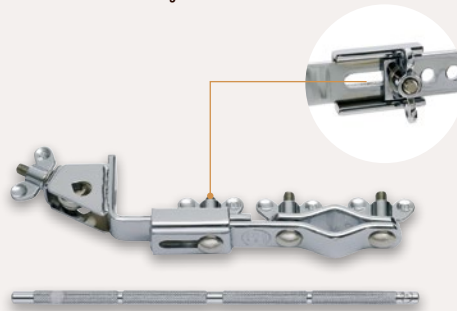

## DOUBLE EXTENSION ARM

Attach a cymbal stack, bongo, or another accessory to any stand with the Meinl Double Extension Arm. It is length adjustable, attaches to any hardware tubing, and is fully adjustable which allows you to fine-tune your angles. Its heavy-duty chrome plated steel construction safely holds heavy items.

**MDEA**



## X-HAT CYMBAL STAND ADAPTER

Instantly modify any 8 mm threaded cymbal stand into a fixed X-Hat stand. The adapter simply screws on the cymbal stand allowing to add a pair of hihats or a cymbal stack whenever is most desired. Clutch is included.

**MXHA**



## X-HAT AUXILIARY HIHAT ARM WITH CLAMP

Add a pair of hihats or a cymbal stack to your drum set up with this multi-adjustable attachment.

**MXH**

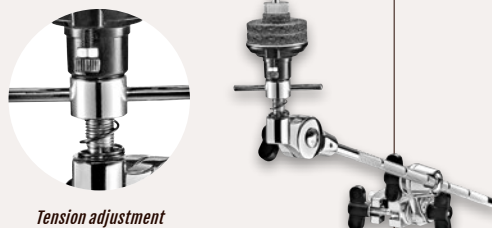

*Tension adjustment*

## CYMBAL ATTACHMENT

Add another cymbal to your set-up with this multi-clamp and boom-arm combo.

**MCA**



## CAJON DRUM SET STANDS

The Meinl Cajon Drum Set Stands allow you to build a cymbal set around your cajon while keeping your stage footprint low-key.

- CCS** Cajon Cymbal Stand
- CHS** Cajon Hi-Hat Stand

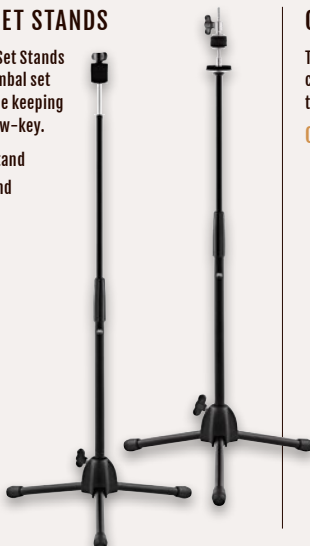

## CAJON MICROPHONE STAND

The Meinl Cajon Microphone Stand is height adjustable and compatible with any standard microphone. It is designed to offer optimal mic placement for your cajon.

**CMS**



*Height adjustable*

## BASS DRUM MICROPHONE CLAMP

The Meinl Bass Drum Microphone Clamp consists of a U-shape 3/8" diameter rod with threaded end, and a bass drum hoop clamp which are designed to offer optimal mic placement for your bass drum.

**MC-MRBD**



### MICROPHONE CONNECTOR

This rod has a threaded connection for microphones and together with the Meinl Rimclamp (sold separately) makes for easy mic placement around a drum kit or percussion set.

**MC-MR1-S**



### MICROPHONE ADAPTER

Transform your cymbal stand into a microphone stand by threading the Meinl Mic Adapter onto it.

**TMMA** 8 mm threaded attachment



### MICROPHONE ROD COUNTER NUTS

Securely lock your microphone to a rod with these counter nuts keeping everything at the proper angle when attached.

**MRCN5** 5pcs Set



### RIM CLAMP

Grab on to any common drum rim with this clamp to securely mount microphones, accessories, or small cymbals exactly where you need them. Useful in drum set ups, percussion rigs, and on marching drums.

**RIMCLAMP-2**



### FLEXIBLE MICROPHONE GOOSENECK

The flexible microphone gooseneck provides easy mic placement on any drum or percussion instrument.

**FMG**



### MIC RIM CLAMP

The Meinl Rim Clamp and Flexible Microphone Gooseneck are also available as a complete ready-to-go set for easy microphone attachment to any common drum rim.

**RIMCLAMP-M**



### PROFESSIONAL MULTI CLAMP WITH FLEXIBLE MICROPHONE GOOSENECK

The Meinl Professional Multi Clamp was designed to securely attach to Conga Rims but also works on other drums too. The gooseneck, which is included, gives you the ability to place the microphone exactly where you need it in your percussion rig.

**TMPMC-G**



### LAPTOP TABLE STAND

The Meinl Laptop Table Stand features everything you need to secure and optimize your computer while performing on-stage.

**TMLTS** 20" x 12 1/2"

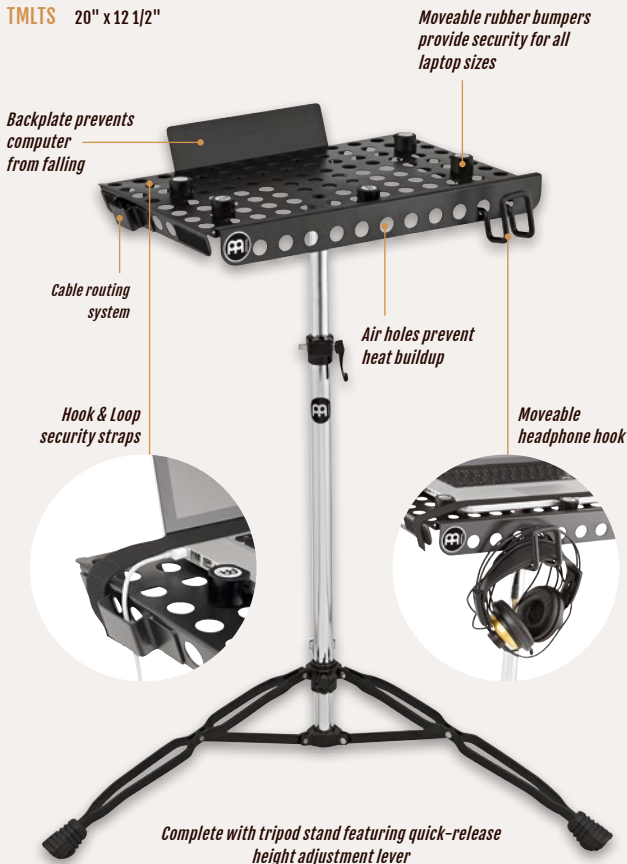

Complete with tripod stand featuring quick-release height adjustment lever

### LIGHT LAPTOP TABLE STAND

Light, travel-friendly laptop stand with foldable legs. Holds laptops up to 16". Height adjustable.

**MLLTS** 14.5" x 10 3/4"



# HARDWARE

## PERCUSSION TABLES

Great for holding onstage accessories.  
Made from durable materials and offer enough room for all common drum gear instruments. The angle of the tables can be adjusted.

- MC-PTXS 11" x 7"
- MC-PTS 12" x 12"
- MC-PT 18" x 12"

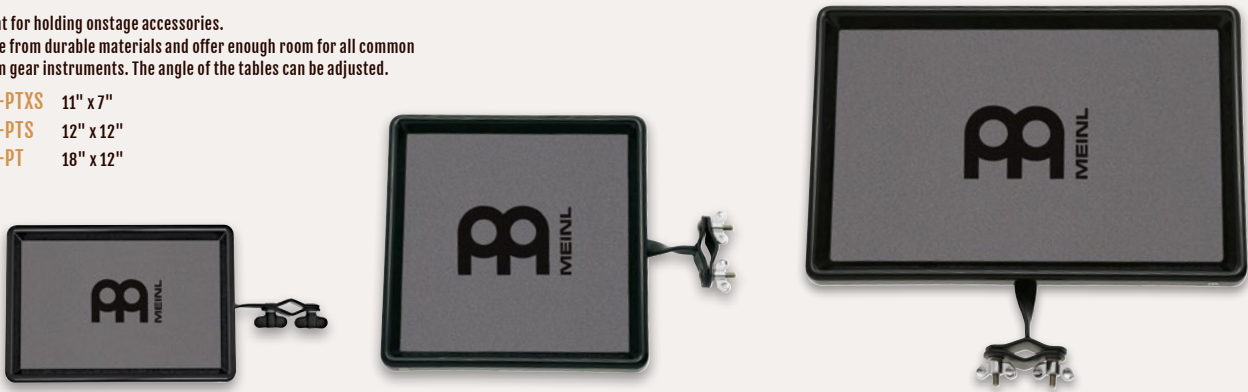

## DRUM TECH KIT

The Meinl Drum Tech Kit provides security beyond just a drum key. We carefully assembled a kit that will cover you for emergencies, routine maintenance, restoration projects or replacing lost parts. This bundle is perfect for any level of drummer needing to ensure their instrument is always in tip-top shape.

MDTK



Comes with storage box

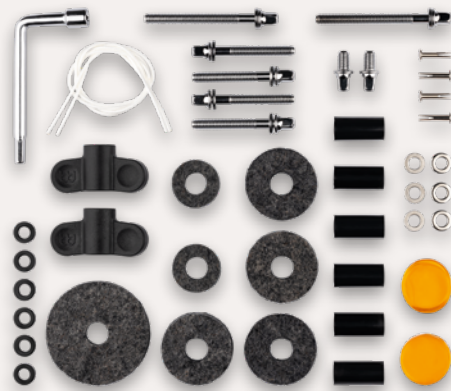

- Includes:**
- 1x L-Shaped Drum Key
  - 4x Drum Honey Gel Pads
  - 6x Plastic Cymbal Sleeves
  - 4x Steel Cymbal Rivets
  - 4x Cymbal Felts
  - 2x Hi-hat Clutch Felts
  - 1x Hi-hat Base Felt
  - 2x 8 mm Wing Nuts
  - 6x Metal Washers
  - 6x Plastic Washers
  - 2x Nylon Snare Cords
  - 2x Short Tension Rods
  - 4x Medium Tension Rods
  - 2x Long Tension Rods

# CLEAN & PROTECT

## CYMBAL CLEANER

Ideal for cleaning Brilliant and Traditional finish cymbals.

MCCL



## CYMBAL POLISH

Cleans and polishes Brilliant finish cymbals.

MCP



## CYMBAL PROTECTANT

Seals and protects cymbal surface.

MCPR



## CYMBAL CARE KITS

Keep your cymbals looking like new using these cymbal care kits.

**MCCK-MCCL**  
Cymbal Cleaner & Cymbal Protectant

**MCCK-MCP**  
Cymbal Polish & Cymbal Protectant

Both kits include **FREE** Meinl Cymbal Gloves.



## CYMBAL GLOVES

Made from 100% cotton, use these gloves to prevent fingerprints or oils on the surface of your cymbals.

MHS-WH





DID YOU KNOW MEINL ALSO OFFERS  
HIGH-QUALITY DRUMSTICKS, BRUSHES,  
MULTI-RODS AND MORE?

Visit [meinlstickandbrush.com](http://meinlstickandbrush.com)  
for more info.



All features are subject to change without notice.  
Not responsible for typographic errors. No part of this  
catalog may be reprinted, reproduced, or included  
in any online service in any form in whole or in part,  
without the prior permission of Meinl.

© 2025 Roland Meinl Musikinstrumente GmbH & Co. KG

#### CONCEPT & DESIGN

ercas GmbH & Co. KG  
[[www.ercasdieagentur.de](http://www.ercasdieagentur.de)]

#### CONTENT & DIRECTION

Norbert Saemann, Udo Heubeck

#### PHOTOGRAPHY

Sebastian Jäger, Christian Habermeier  
[[www.studio-waldeck.de](http://www.studio-waldeck.de)]

Tobias Winklmann, Manuel Burdeus Mendoza,  
Sebastian Angele, Norbert Saemann, Mario Schmitt,  
Randy Edwards, Angela Michel, Alex Wohleber,  
Tobias Merkle, Henrik Bergerbusch, Bastian Kückenhoff

#### LITHOGRAPHY

Sven Mihm [[www.mihm-werbung.de](http://www.mihm-werbung.de)]

#### GLOBAL HEADQUARTERS

Roland Meinl Musikinstrumente GmbH & Co. KG  
Musik-Meinl-Straße 1  
91468 Gutenstetten  
Germany  
[info@meinlcymbals.com](mailto:info@meinlcymbals.com)

#### NORTH AMERICAN HEADQUARTERS

Meinl USA L.C.  
3427 Ambrose Avenue  
Nashville, TN 37207  
USA  
[info@meinlusa.com](mailto:info@meinlusa.com)

Printed in Germany M-CA161124





*Handwritten signature*

**M** MEINL

CYM-CATALOG25



8 42960 11434 8